

# ESOTERIC

AI-10

Digital Integrated Amplifier

OWNER'S MANUAL ..... 2

MANUEL DU PROPRIÉTAIRE ... 21



**CAUTION**  
RISK OF ELECTRIC SHOCK  
DO NOT OPEN



CAUTION: TO REDUCE THE RISK OF ELECTRIC SHOCK, DO NOT REMOVE COVER (OR BACK). NO USER-SERVICEABLE PARTS INSIDE. REFER SERVICING TO QUALIFIED SERVICE PERSONNEL.



The lightning flash with arrowhead symbol, within an equilateral triangle, is intended to alert the user to the presence of uninsulated "dangerous voltage" within the product's enclosure that may be of sufficient magnitude to constitute a risk of electric shock to persons.



The exclamation point within an equilateral triangle is intended to alert the user to the presence of important operating and maintenance (servicing) instructions in the literature accompanying the appliance.

## IMPORTANT SAFETY INSTRUCTIONS

- 1) Read these instructions.
  - 2) Keep these instructions.
  - 3) Heed all warnings.
  - 4) Follow all instructions.
  - 5) Do not use this apparatus near water.
  - 6) Clean only with dry cloth.
  - 7) Do not block any ventilation openings. Install in accordance with the manufacturer's instructions.
  - 8) Do not install near any heat sources such as radiators, heat registers, stoves, or other apparatus (including amplifiers) that produce heat.
  - 9) Do not defeat the safety purpose of the polarized or grounding-type plug. A polarized plug has two blades with one wider than the other. A grounding type plug has two blades and a third grounding prong. The wide blade or the third prong are provided for your safety. If the provided plug does not fit into your outlet, consult an electrician for replacement of the obsolete outlet.
  - 10) Protect the power cord from being walked on or pinched particularly at plugs, convenience receptacles, and the point where they exit from the apparatus.
  - 11) Only use attachments/accessories specified by the manufacturer.
  - 12) Use only with the cart, stand, tripod, bracket, or table specified by the manufacturer, or sold with the apparatus. When a cart is used, use caution when moving the cart/apparatus combination to avoid injury from tip-over.
- 
- 13) Unplug this apparatus during lightning storms or when unused for long periods of time.
  - 14) Refer all servicing to qualified service personnel. Servicing is required when the apparatus has been damaged in any way, such as power-supply cord or plug is damaged, liquid has been spilled or objects have fallen into the apparatus, the apparatus has been exposed to rain or moisture, does not operate normally, or has been dropped.

- Do not expose this apparatus to drips or splashes.
- Do not place any objects filled with liquids, such as vases, on the apparatus.
- Do not install this apparatus in a confined space such as a book case or similar unit.
- The apparatus draws nominal non-operating power from the AC outlet with its STANDBY/ON switch in the standby position.
- The apparatus should be located close enough to the AC outlet so that you can easily grasp the power cord plug at any time.
- An apparatus with Class I construction shall be connected to an AC outlet with a protective grounding connection.
- Batteries (battery pack or batteries installed) shall not be exposed to excessive heat such as sunshine, fire or the like.
- Excessive sound pressure from earphones and headphones can cause hearing loss.

**WARNING: TO PREVENT FIRE OR SHOCK HAZARD, DO NOT EXPOSE THIS APPLIANCE TO RAIN OR MOISTURE.**

### CAUTION

- DO NOT REMOVE THE EXTERNAL CASES OR CABINETS TO EXPOSE THE ELECTRONICS. NO USER SERVICEABLE PARTS ARE WITHIN!
- IF YOU ARE EXPERIENCING PROBLEMS WITH THIS PRODUCT, CONTACT TEAC FOR A SERVICE REFERRAL. DO NOT USE THE PRODUCT UNTIL IT HAS BEEN REPAIRED.

## For U.S.A.

This equipment has been tested and found to comply with the limits for a Class B digital device, pursuant to Part 15 of the FCC Rules. These limits are designed to provide reasonable protection against harmful interference in a residential installation. This equipment generates, uses, and can radiate radio frequency energy and, if not installed and used in accordance with the instructions, may cause harmful interference to radio communications. However, there is no guarantee that interference will not occur in a particular installation. If this equipment does cause harmful interference to radio or television reception, which can be determined by turning the equipment off and on, the user is encouraged to try to correct the interference by one or more of the following measures:

- Reorient or relocate the equipment and/or the receiving antenna.
- Increase the separation between the equipment and receiver.
- Connect the equipment into an outlet on a circuit different from that to which the receiver is connected.
- Consult the dealer or an experienced radio/TV technician for help.

### CAUTION

Changes or modifications to this equipments not expressly approved by TEAC CORPORATION for compliance will void the user's warranty.

### CAUTION Regarding Placement

To maintain proper ventilation, be sure to leave a space around the unit (from the largest outer dimensions including projections) equal to, or greater than, shown below.

Left and Right Panels: 5 cm (2")  
Rear Panel: 10 cm (4")  
Top Panel: 20 cm (8")

### For European customers

#### Disposal of your old appliance

1. When this crossed-out wheeled bin symbol is attached to a product it means the product is covered by the European Directive 2002/96/EC.
2. All electrical and electronic products should be disposed of separately from the municipal waste stream via designated collection facilities appointed by the government or the local authorities.
3. The correct disposal of your old appliance will help prevent potential negative consequences for the environment and human health.
4. For more detailed information about disposal of your old appliance, please contact your city office, waste disposal service or the shop where you purchased the product.



## Contents

**Thank you for choosing Esoteric. Read this manual carefully to get the best performance from this unit.**

Contents	3
Before Use	4
Speaker Connection	4
Connection	6
Restoring factory settings	9
Remote Control Unit	9
Identifying the Parts	10
Basic Operation	12
Muting	13
Display Dimming	13
Word Sync	13
Gain Setting for Analog Audio Input	14
Name and Skip Setting of the INPUT Knob	15
Settings for Word Sync, Volume and i.LINK*	16
i.LINK (IEEE 1394)*	18
Troubleshooting	19
Specifications	20

\*: Functions concerning the i.LINK (AUDIO) terminals has no effect at the moment. They will become available after a future hardware upgrade (charged).

"Super Audio CD" is a registered trademark.  
"DSD" is a registered trademark.

The i.LINK logo is a trademark of Sony Corporation, registered in the U.S. and other countries.

## Before Use

### What's in the box

Please confirm that the following accessories are in the box when you open it.

Remote control unit x 1  
Batteries (AA, R6, SUM-3) x 2  
Felt sheet x 3  
Power cord x 1  
Owner's manual x 1  
Warranty card x 1

### Read this before operation

- Be careful to avoid injury when moving the unit, on account of its weight. Get someone to help you if necessary.
- To protect easily scratched furniture, you may stick the felt supplied with the unit to the feet.
- As the unit may become warm during operation, always leave sufficient space around the unit for ventilation. The ventilation holes should not be covered. Make sure there is at least 20 cm (8") of space above and at least 5 cm (2") of space on each side of the unit. Do NOT place anything on top of the unit.
- The voltage supplied to the unit should match the voltage as printed on the rear panel. If you are in any doubt regarding this matter, consult an electrician.
- Choose the installation location of your unit carefully. Avoid placing it in direct sunlight or close to a source of heat. Also avoid locations subject to vibrations and excessive dust, heat, cold or moisture.
- Do not place the unit on the amplifier/receiver.
- Do not open the cabinet as this might result in damage to the circuitry or electrical shock. If a foreign object should get into the unit, contact your dealer or service company.
- When removing the power plug from the wall outlet, always pull directly on the plug, never yank the cord.
- Do not attempt to clean the unit with chemical solvents as this might damage the finish. Use a clean, dry cloth.
- Keep this manual in a safe place for future reference.

### Maintenance

If the surface of the unit gets dirty, wipe with a soft cloth or use diluted neutral cleaning liquid. Be sure to remove any fluid completely. Do not use thinner, benzine (naphtha) or alcohol as they may damage the surface of the unit.

## Speaker Connection

### CAUTION:

- Switch off the power to all equipment before making connection.
- Read the instructions of each component you intend to use with this unit.
- Be sure to insert each plug securely. To prevent hum and noise, avoid bundling the signal interconnection cables together with the AC power cord or speaker cables.

### Note:

- Use commercially available speaker cables. Ideally, left and right speaker cables should be the same length. And the length of cables should be as short as possible for better sound quality.
- The black speaker terminals are – (negative). Generally, the + side of the speaker cable is marked to make it distinguishable from the – side of the cable. Connect this marked side to the + terminal and the unmarked side to the black – terminal.
- The metal portions of the two separate wires should not touch or an electrical short can occur. Shorted wires can create a fire hazard or induce a failure in your equipment.

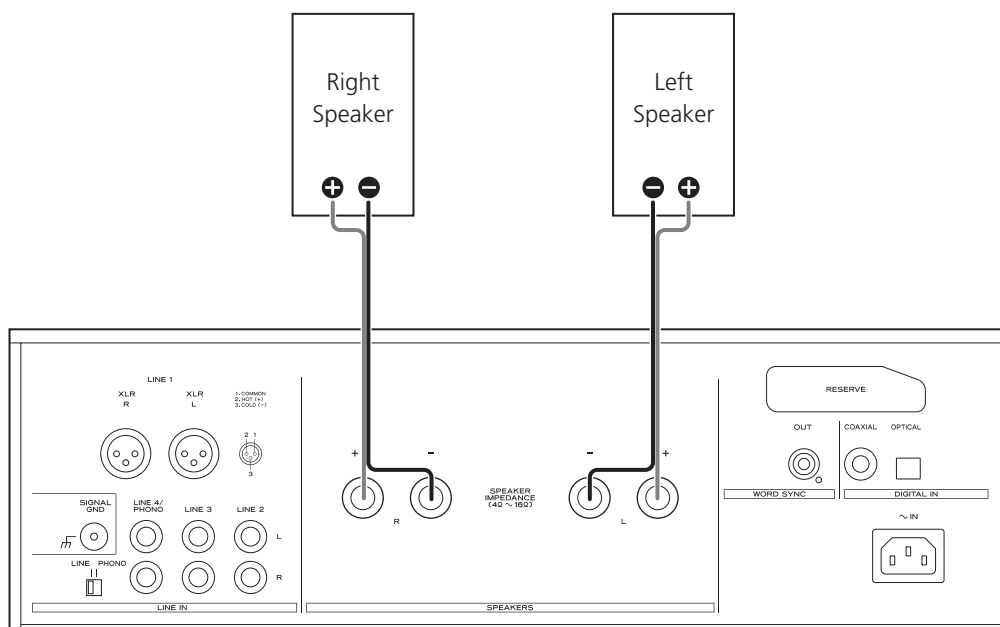

### Connection using speaker cables with spades or bare wire

1. Turn the terminal cap counterclockwise to loosen it. The speaker terminal caps cannot be fully removed from the base.
2. Insert the wire or spade into the terminal and turn the terminal cap clockwise to securely connect it:

Make sure none of the wire insulation is under the terminal, only the bare, stripped wire.

3. Make sure it is fastened firmly by pulling the cable lightly.

- The inside diameter of spades should be 8 mm or more.

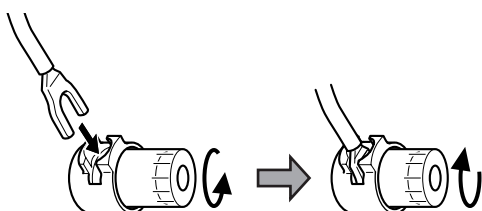

### When your speaker cable has bare wire at the end

Prepare the speaker cables for connection by stripping off approximately 10 mm (1/2") or less of the outer insulation. (Removing too much insulation may lead to a short circuit if the bared wires should come in contact with each other.) Twist the strands of the stripped wires tightly together. The thickness of wires should be less than 4 mm (1/8").

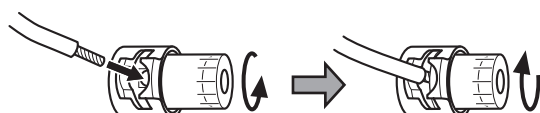

### Connection using speaker cables with banana plugs

Tighten the terminal cap and insert a banana plug.

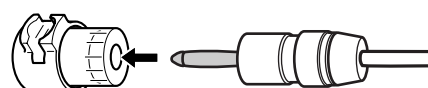

### For European customers

In accordance with European safety regulations, it is not possible to connect banana plugs into the speaker terminals on European models.

The holes into which banana plugs are inserted have been covered with black caps. Connect the speakers using spades or bare wires.

If the black caps become separated from the terminals, return them to their original position.

# Connection (1)

**CAUTION:**

- Switch off the power to all equipment before making connection.
- Read the instructions of each component you intend to use with this unit.
- Be sure to insert each plug securely. To prevent hum and noise, avoid bundling the signal interconnection cables together with the AC power cord or speaker cables.

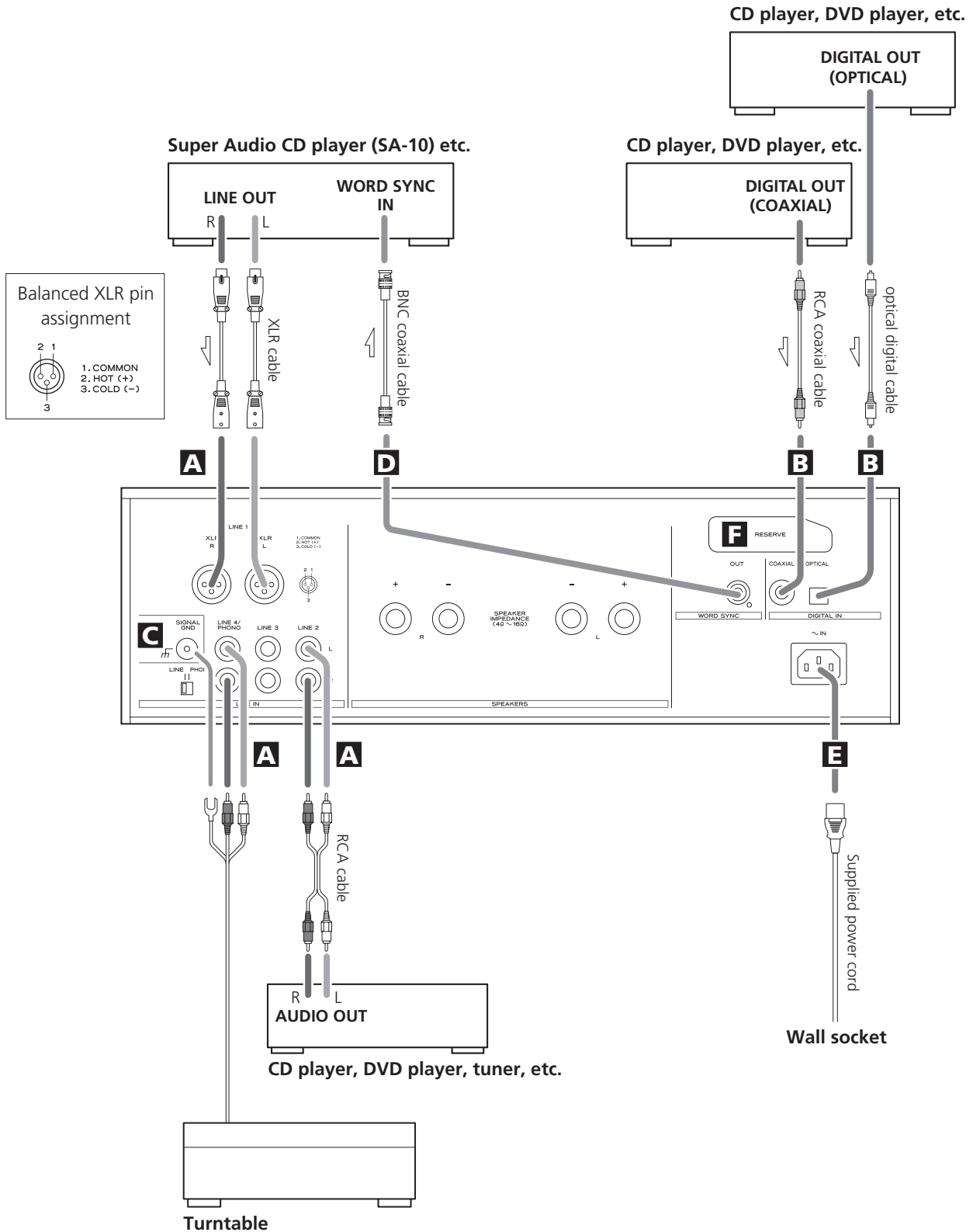

## **A** Analog audio input terminals [LINE IN]

Used for the input of analog 2-channel audio signals. Connect these terminals to a Super Audio CD player (SA-10), cassette tape deck, tuner, etc. using commercially available XLR or RCA audio cables.

Make sure to connect:

- white plug → white jack (L: left channel)
- red plug → red jack (R: right channel)

### **LINE4/PHONO terminals**

In addition to a cassette tape deck or tuner, you can also connect a turntable to the LINE4/PHONO terminals. Connect the ground lead of the turntable to the SIGNAL GND terminal of the AI-10. (But if low frequency noises are heard, it might be better not to connect the ground lead.)

The cartridge of the turntable should be Moving Magnet or similar.

### **LINE/PHONO switch**

Select PHONO when a turntable is connected to the LINE4/PHONO terminals. Select LINE4 when a cassette tape deck, tuner, etc. is connected to the LINE4/PHONO terminals.

## **B** Digital audio input terminals [DIGITAL IN]

Used for the input of digital audio signals from CD, DVD, etc.

The unit may be connected to digital audio source units such as CD players, DVD players, etc.

Use commercially available cables.

- COAXIAL: RCA (pin) digital audio cable
- OPTICAL: optical digital audio cable (TOS)

- The optical terminal is covered by a shutter. Make sure that the cable is firmly inserted, but do not force the cable when connecting it or removing it, in order not to cause damage to the unit.
- The COAXIAL and OPTICAL terminals cannot transmit the digital audio from Super Audio CDs.
- The AI-10 isn't equipped with Dolby Digital/DTS/MPEG decoders. The digital output setting of the connected DVD player must be "PCM".

## **C** SIGNAL GND connection

Use a commercially available PVC-covered cord to connect the signal ground terminal on the unit to the player's signal ground.

- Note that this is NOT an electrical safety ground (earth).
- When a turntable is connected, make sure to connect the ground lead of the turntable.

## **D** WORD SYNC output terminal

This terminal sends out a sync signal (word).

Connect this to the WORD IN terminal of a digital device such as the SA-10, UZ-1, etc.

For connection, use a commercially available BNC coaxial digital cable (75Ω impedance).

## **E** Power cord receptacle

After all other connections have been made, insert the supplied AC power cord into this receptacle, then connect the other end of the power cord into the wall socket.

- Ensure that your AC voltage corresponds to the voltage marked on the rear panel of the unit. Consult a qualified electrician if you are in doubt.
- Use only the supplied Esoteric power cord. Use of other power cords may result in fire or electric shock. Unplug the power cord when you are not going to use the unit for an extended period of time.

### **F** Reserved slot for i.LINK (AUDIO) terminals

The i.LINK (AUDIO) terminals (4 pin x 1, 6 pin x 1) will become available after a future hardware upgrade (charged).

In addition to the digital audio from CD and DVD, the i.LINK (AUDIO) terminals can transmit the digital audio from Super Audio CDs.

Connect the i.LINK (AUDIO) terminal to a digital audio source unit such as a Super Audio CD player (SZ-1, SA-10 (upgraded), etc.).

Use a commercially available S400 compatible i.LINK (IEEE1394) cable (6 pin or 4 pin).

- The i.LINK (AUDIO) terminal is an interface that transmits data both ways between the AI-10 and an external device. You don't need to be concerned with distinguishing between inputs and outputs.

When multiple AI-10's (upgraded) are connected using i.LINK cables as shown below, you can enjoy surround sound from Super Audio CD, DVD-Video and DVD-Audio.

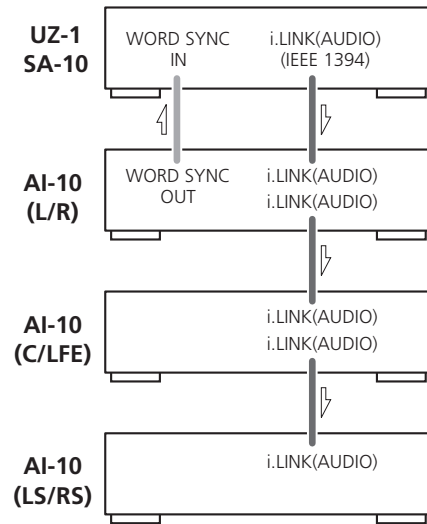

**Following settings are necessary for this connection:**

#### **AI-10**

INPUT	"i.LINK" (see page 12)
WORD button	One of the AI-10 that receives channel L/R: "W_OUT" The others: "OFF" (see page 13)
W_OUT setting	"176.4" or "88.2" (see page 16)
CH setting	respective channels (see page 17)
i_RC setting	"ON" (see page 17)

#### **SZ-1/UZ-1/SA-10 (upgraded)**

i.LINK button	"PCM"
WORD button	"ON"
Analog Out setting	"Multi ch"
Digital Out setting	"ON"
CD Direct setting	"Normal"
Speaker setting	necessary



## Remote Control Unit

### How to insert the batteries

Remove the cover of the remote control unit with a screwdriver. After checking the polarity ( $\oplus/\ominus$ ) of two AA batteries, insert the batteries, replace the cover and replace the screws.

- Take care not to pinch cables with the battery case.

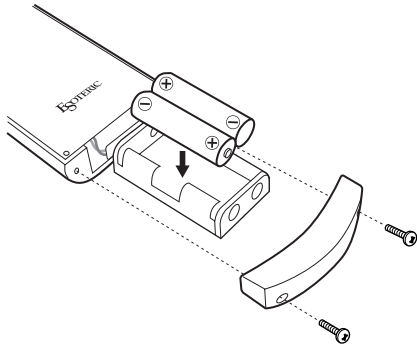

### Battery Replacement

If the distance required between the remote control unit and main unit decreases, the batteries are exhausted. In this case replace the batteries with new ones.

### Precautions concerning batteries

- Be sure to insert the batteries with correct positive " $\oplus$ " and negative " $\ominus$ " polarities.
- Use batteries of the same type. Never use different types of batteries together.
- Rechargeable or non-rechargeable batteries can be used but not mixed together. Refer to the precautions on their labels.
- When the remote control unit is not to be used for a long time (more than a month), remove the batteries from the remote control unit to prevent them from leaking. If they leak, wipe away the liquid inside the battery compartment and replace the batteries with new ones.
- Do not heat or disassemble batteries and never dispose of old batteries by throwing them in a fire.

### Notes on use

- Point the remote control unit at the player's remote sensor within seven meters (23 feet) of the player. There should not be any obstacles between the player and the remote control unit.
- Do not allow direct sun or other light to shine on the remote sensor part of the player. This may cause the remote control unit to work incorrectly.
- Note that other units with remote controls may operate incorrectly because of infrared light "overspill" when you operate this remote control unit.

## Restoring factory settings

If you have made a lot of changes to the setup, and want to restart from a known set of options, restore the unit to the factory settings as follows:

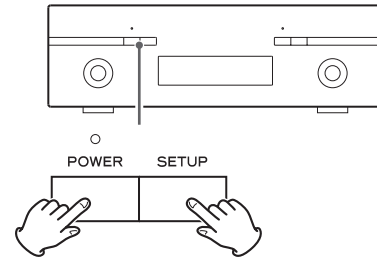

1. Turn the unit off and wait 30 seconds or longer.
2. Press the **POWER** button while holding down the **SETUP** button.

Release the SETUP button when "Setup CLR" appears on the display.

All memories are erased, and the unit returns to the factory settings.

# Identifying the Parts

## Front Panel

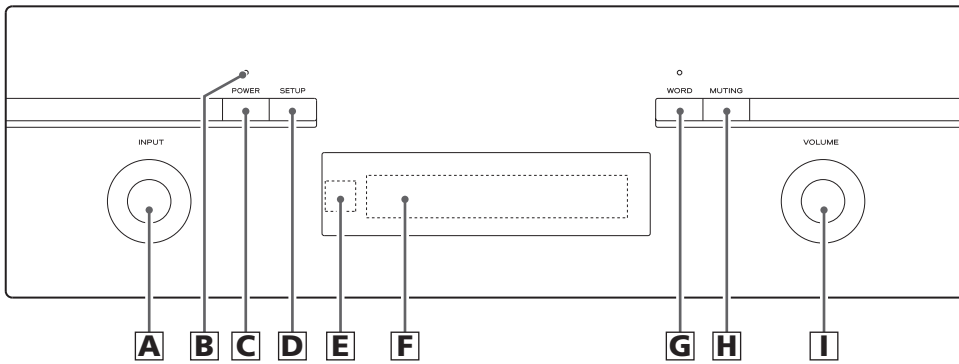

## Display

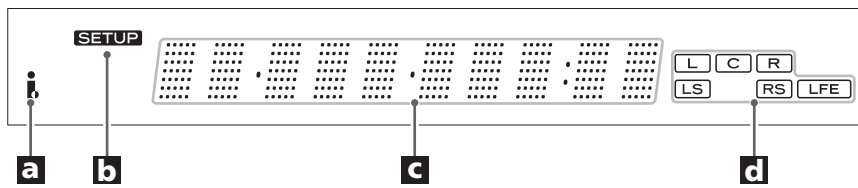

## Remote Control Unit

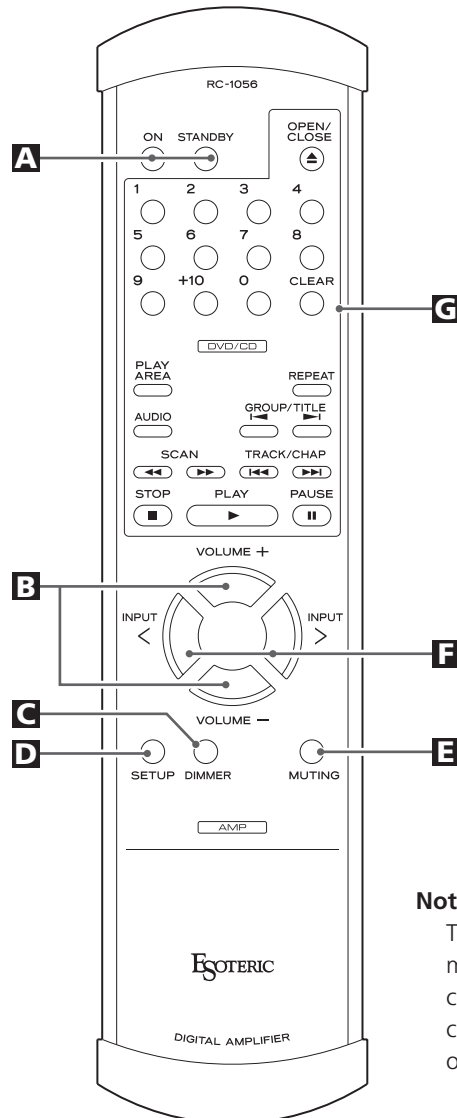

### Note:

To simplify explanations, instructions in this manual refer to the names of the buttons and controls on the front panel only. Associated controls on the remote control will also operate similarly.

## Front Panel

### A INPUT

Turn this knob to select an input.  
In the setup mode, use this knob to change settings.

### B Power indicator

#### Blue (on)

The POWER button of the main unit is ON.

#### Red (standby)

When the POWER button is depressed, press the STANDBY button of the remote control unit to turn the unit standby.  
In the standby mode, press the ON button of the remote control unit to turn the unit ON.

#### Off

The POWER button of the main unit is OFF.

### C POWER

Use this button to turn the unit on and off.

### D SETUP

Press this button to enter or exit the setup mode (see pages 14-17).

### E Remote control sensor

Receives signals from the remote control unit. Point the remote control unit at this sensor when operating the remote control unit.

### F Display

### G WORD

Use this to turn on or off the word sync function.  
The indicator lights when the word sync is on.

### H MUTING

Use this button to mute the sound.

### I VOLUME

Turn this knob to adjust the volume.

## Display

### a i.LINK indicator

After a future hardware upgrade (charged), this indicator will light when the INPUT knob is set to "i.LINK" or when "i\_RC" is set to ON (see page 17).

This indicator blinks when the unit cannot perceive the digital signal.

### b SETUP indicator

Lights while in the setup mode.

### c Message area

Normally, "current input" and volume are shown on the display.

"OPT" or "COAX" blinks when the unit cannot perceive the digital signal from the OPTICAL or COAXIAL terminal.

After a future hardware upgrade (charged), if a device is connected to the i.LINK (AUDIO) terminal, the display will show its model name (such as SA-10) instead of "current input".

"UNKNOWN" will appear if the unit cannot find the model name.

### d Channel indicators

When the INPUT knob is set to "i.LINK" after a future hardware upgrade (charged), channels selected in the "CH" setup will light (see page 17).

## Remote Control Unit

### A STANDBY/ON

When the POWER button of the main unit is depressed, press the STANDBY button to turn the unit standby.

In the standby mode, press the ON button to turn the unit ON.

When you press the ON button, white buttons on the remote control unit light for several seconds.

### B VOLUME

Use these buttons to adjust the volume.

### C DIMMER

Use this button to change the brightness of the front panel display.

### D SETUP

Use this button in "Settings for Word Sync, Volume and i.LINK" on page 16.

Note that this button doesn't work in "gain setting" or "name and skip setting" (see pages 14 and 15).

### E MUTING

Use this button to mute the sound.

### F INPUT

Use these buttons to select an input.

### G Buttons for the basic operation of Esoteric SA-10, SZ-1 or UZ-1

You can use these buttons to operate Esoteric SA-10, SZ-1 or UZ-1.

Point the remote control unit at the remote sensor of the SA-10, SZ-1 or UZ-1.

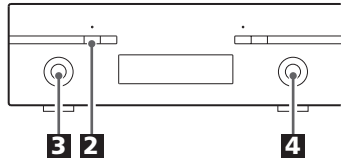

**1** First of all, turn on the power of the connected components.

**2** Press the POWER button to turn the AI-10 on.

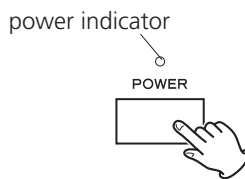

If the power indicator is red, press the ON button of the remote control unit to turn the unit on (see page 11).

It may take several seconds for the unit to start outputting sounds. Wait until "WAIT ..." disappears from the display.

**3** Select an input by turning the INPUT knob.

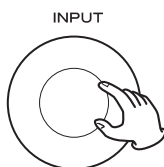

The current input appears on the left of the display. Repeatedly turn the knob until the desired input appears on the display.

COAX, OPT, LINE1, LINE2, LINE3,  
LINE4 or PHONO\*, i.LINK\*\*

\*: PHONO appears only when the LINE/PHONO switch is set to PHONO.

• "COAX" or "OPT" blinks when the unit cannot perceive the digital signal. In that case, connect a digital device to the DIGITAL IN (COAXIAL or OPTICAL) terminal and switch it on.

\*\* : "i.LINK" will be added after a future hardware upgrade (charged). i.LINK indicator blinks when the unit cannot perceive the digital signal. In that case, connect a digital device to the i.LINK(AUDIO) terminal and switch it on.

**4** Play the source, and gradually turn up the volume to the required level by turning the VOLUME knob.

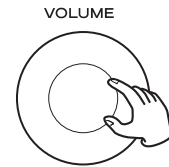

**To turn the unit off (standby)**

To prevent sudden noise from the speakers, make sure to turn the unit off in the following way.

**1. Stop the playback of the connected component.**

**2. Turn the AI-10 off using the POWER button.**

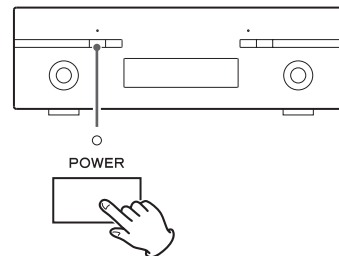

• Use the STANDBY button of the remote control unit to turn the AI-10 standby.

**3. Turn the connected components off.**

## Muting

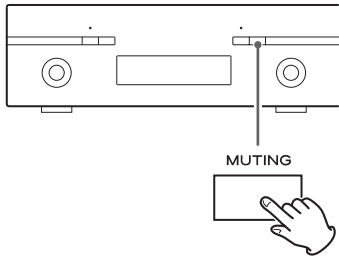

To mute the sound temporarily, press the MUTING button. Press the MUTING button again to restore the sound.

- While muting is engaged, "MUTING" and the name of the selected terminal alternately blink on the display.

## Display Dimming

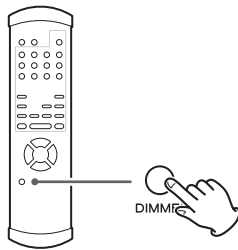

The display on the main unit can be dimmed to suit the environment in which you listen to music.

**Use the DIMMER button to cycle between these settings.**

### FL Dimmer3:

Full brightness

### FL Dimmer2:

Medium brightness

### FL Dimmer1:

Minimum brightness

### OFF:

The display and indicators are off.

- Note that the OFF setting is not memorized when the power is turned off. When the unit is switched off with the display off, and then turned on again, the display is reset to the minimum brightness (FL Dimmer1).
- In OFF mode, when you press a button such as VOLUME, the illuminations turn temporarily on.

## Word Sync

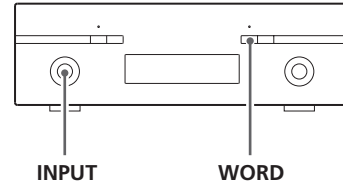

This feature is used when you want to get your whole system locked to a single sync signal (clock) by connecting this unit to the Esoteric SA-10/UZ-1 or other devices that are capable of inputting a sync signal (word clock).

- 1 Select an input to be changed by turning the INPUT knob.**

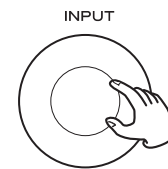

Word sync and its frequency can be set independently for each input.

- 2 Use the WORD button to switch between W\_OUT and WORD OFF.**

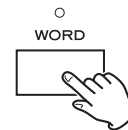

### W\_OUT (on)

The unit internally generates and sends out Word Clock. The indicator lights.

You can change the frequency of the word sync signal. See page 16 for details.

- Make WORD SYNC connections before powering on the unit.
- It takes several seconds to detect and lock to a clock. If the received digital signal doesn't match the sync signal, the display shows "WRD ERROR!".

### WORD OFF (off)

The unit does not output a word clock.

- Settings are stored even when power is turned off and the unit is unplugged. If left unplugged for an extended period, the settings may be lost.

## Gain Setting for Analog Audio Input

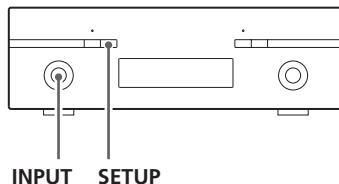

You can adjust the relative volume between the LINE IN terminals. Once the relative volume is set, each component connected to the AI-10 will have the approximate same volume level.

### 1 Select an input to be changed (LINE1, LINE2, LINE3 or LINE4/PHONO) by turning the INPUT knob.

Start with the component that has the lowest volume level.

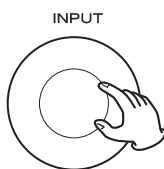

### 2 Press and hold the SETUP button for more than 2 seconds.

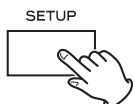

The unit enters setup mode, and "GainL\*>\*\*\*" appears on the display. (\*\*\*) changes depending on your setting.)

If you leave the unit idle for 10 seconds, the setup mode will be cancelled.

### 3 Turn the INPUT knob to change the Gain setting.

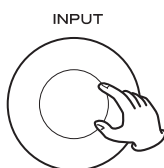

Adjustable range: 0, +3, +6, +9, +12, +15, +18, +21, +24

### 4 Press and hold the SETUP button for more than 2 seconds (or leave the unit idle for 10 seconds) to exit the Gain setup mode.

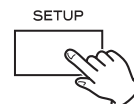

- Settings are stored even when power is turned off and the unit is unplugged. If left unplugged for an extended period, the settings may be lost.
- If you lightly press the SETUP button, the unit enters name and skip setting mode. See page 15 for details.

# Name and Skip Setting of the INPUT Knob

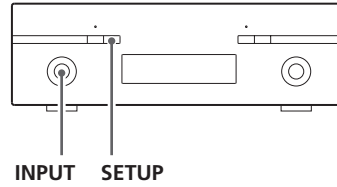

The names of the inputs shown on the display can be changed. You can also set the INPUT knob to skip the input terminals that are not in use.

## Example:

When a CD player is connected to the COAX (coaxial) terminal and a DVD player to the OPT (optical) terminal

- Select "CD" for COAX.
- Select "DVD" for OPT.
- Select "\*skip" for other terminals.

Then only "CD" or "DVD" will appear on the display when you turn the INPUT knob.

## 1 Press and hold the SETUP button for more than 2 seconds.

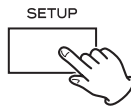

The unit enters setup mode, and "L-1>\*\*\*" appears on the display. (\*\*\*) changes depending on your setting.)

If the INPUT knob is set to LINE (1, 2, 3 or 4) or PHONO, "GainL\*>\*\*\*" will appear instead of "L-1>\*\*\*". In this case, lightly press the SETUP button again to show "L-1>\*\*\*".

If you leave the unit idle for 10 seconds, the setup mode will be cancelled.

## 2 Repeatedly press the SETUP button to select the input terminal to be changed.

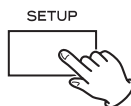

- L-1 (LINE1) → L-2 (LINE2) → L-3 (LINE3)
- L-4 (LINE4) → i-L (i.LINK)\* → C-1 (COAX)
- O-1(OPT) → (normal display)
- L-1(LINE1) → ...

\*: "i-L" will be added after a future hardware upgrade (charged).

## 3 Turn the INPUT knob to change the setting.

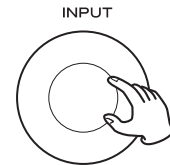

Default name, CD, SACD, DVD, TUNER, MD, CD-R, TAPE, PHONO, MP3, TV, SAT, CATV, DVD-R, VCR, \*skip

- The default name of the LINE4 terminal depends on the LINE4/PHONO switch. When the LINE/PHONO switch is set to LINE, the default name is "LINE4". When the LINE/PHONO switch is set to PHONO, the default name is "PHONO".
- Skip function will not work at all if you set all the input terminals to "\*skip".
- The name of the i.LINK terminal cannot be changed, as the display always shows model name of the connected device. Only "\*skip" is selectable for i.LINK.

## 4 Press and hold the SETUP button for more than 2 seconds (or leave the unit idle for 10 seconds) to exit the setup mode.

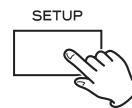

- Settings are stored even when power is turned off and the unit is unplugged. If left unplugged for an extended period, the settings may be lost.

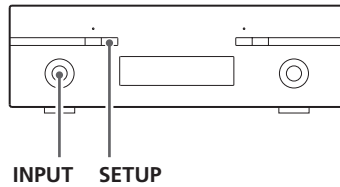

- 1** If you want to change “W\_OUT (Word sync output frequency)”, select an input to be changed by turning the INPUT knob.

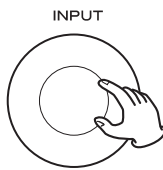

“W\_OUT” can be set independently for each input, while “S\_VOL” is applied to all inputs.

- 2** Repeatedly press the SETUP button to select the menu item to be changed.

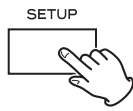

If you leave the unit idle for 10 seconds, the setup mode will be cancelled.

- 3** Turn the INPUT knob to select the options within the menu item.

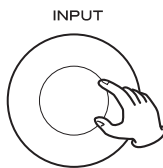

- Repeat steps **2** and **3** as required.

- 4** Repeatedly press the SETUP button (or leave the unit idle for 10 seconds) to exit the setup mode.

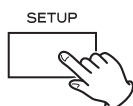

- Settings are stored even when power is turned off and the unit is unplugged. If left unplugged for an extended period, the settings may be lost.

## Available menu item and options

### W\_OUT (Word sync output frequency)

Select the frequency of the word sync signal. The factory setting is “100”.

100 ↔ 44.1 ↔ 88.2 ↔ 176(176.4) ↔ 48 ↔ 96 ↔ 192

- The word sync signal is output only when the WORD button is set to “W\_OUT” (see page 13).

### S\_VOL (starting volume)

#### OFF (default)

The unit turns on with the last volume adjusted by the VOLUME knob.

#### “- - -” to “-20dB”

The unit always turns on with the volume you set here.

The level can be adjusted in 1 dB steps from - - - (-∞: no sound) to -20 dB.

“CH” and “i\_RC” (settings for i.LINK) will be added after a future hardware upgrade (charged).

### (Normal display)

Select this to exit the setup mode.



**"CH" and "i\_RC" will become available after a future hardware upgrade (charged).**

## CH (Channel)

When the i.LINK (AUDIO) terminal is connected to a digital device, select the channels for this unit.

The factory setting is L/R.

L/R: front left and right channels

C/LFE: center channel and LFE (subwoofer)

LS/RS: surround left and right channels

- The icons of the selected channels light on the display.



## i\_RC (i.LINK remote control function)

When multiple AI-10 units are directly connected using i.LINK cables and you use this function, the volume, muting and dimmer of all AI-10's in the chain can be controlled using only one AI-10.

Since this function is available as long as AI-10's are connected using i.LINK cables, you can use a different input type other than i.LINK.

### ON

The volume, muting and dimmer of all AI-10's in the chain can be controlled using the L/R channel AI-10.

### MASTR

#### SLAVE

When you set one AI-10 as master and all other AI-10's as slaves, the volume, muting and dimmer of all AI-10's in the chain can be controlled using only the master unit.

This master-slave control has nothing to do with the channel setting.

### OFF (factory setting)

Select this setting position when the i.LINK remote control is not used. The volume, muting and dimmer of all AI-10's in the chain cannot be controlled as a whole.

The i.LINK circuit is powered only when the input is set to i.LINK.

### Note

When two AI-10's are connected using i.LINK cables and one AI-10 is connected to the front left speaker and the other AI-10 is connected to the front right speaker as shown below, one AI-10 can be used as an amplifier dedicated to the left channel and the other as an amplifier dedicated to the right channel.

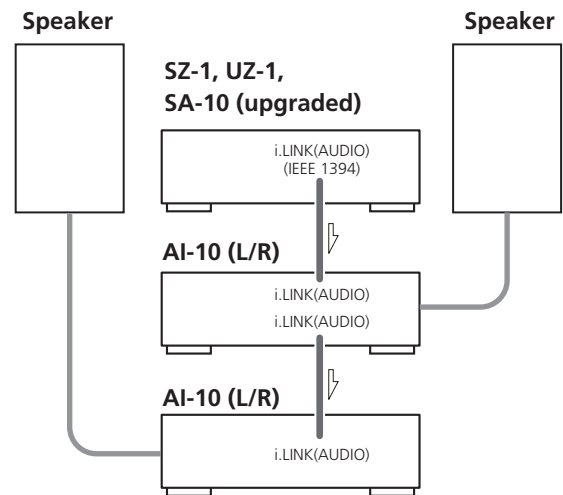

The MASTR and SLAVE settings of the i.LINK remote control function allow you to set one AI-10 as master and the other as slave, so that the volume, muting and dimmer of the two AI-10's can be controlled in unison using one of the pair units.

## The i.LINK (AUDIO) terminals will become available after a future hardware upgrade (charged).

The i.LINK is also known as IEEE 1394, an international specification.

By connecting an i.LINK (AUDIO)-capable device to the i.LINK (AUDIO) terminal on this unit using an i.LINK cable, you can transmit Super Audio CD multi-channel signals that could not be transmitted but in analog format in the past can be transmitted in its original digital format, in addition to the capability of transmitting 2-ch linear PCM data.

If you have multiple i.LINK-capable devices, you can connect them through other devices to transmit data between them, so you don't need to be concerned with the order of connection.

## Copyright protection system DTCP

To play back audio sounds recorded on Super Audio CD using i.LINK, both the player and the D/A converter need to be compliant to the copyright protection system DTCP (Digital Transmission Content Protection).

This unit is DTCP compliant.

## Data transfer rate

There are three transfer rates: 100 Mbps (S100), 200 Mbps (S200), and 400 Mbps (S400). This unit is capable of transferring data at a maximum 400Mbps.

For connection to an i.LINK-capable device, use a commercially available S400-compliant i.LINK cable (6-pin or 4-pin).

When connecting multiple i.LINK-capable devices, avoid connecting a device having a slow transfer rate between devices having high transfer rates since this reduces the transfer rate of the whole system. Connect devices having high transfer rates towards the source as far "up-stream" as possible.

## NOTES

- Among the i.LINK formats there are "MPEG-2 TS" for BS digital sources and "DV" for digital video for DVD recorders, as well as the "i.LINK (AUDIO)" (A&M Protocol). Never connect devices that are not compatible with i.LINK (AUDIO) to this unit. If you do, this unit and other components may not operate normally and may also become damaged.
- In the process of data transfer, avoid plugging/unplugging the i.LINK cables in use or switch on/off the power.
- Among i.LINK-capable devices, there are some that, if not turned on, are not capable of relaying data.
- Some i.LINK-capable devices will not respond to this unit's command. This is normal and is due to incompatibility among i.LINK devices.
- The receiving device may not support the output modes of this unit. Read through the instruction manual of devices you want to connect before making any connections.

## Flow rate control

This unit supports i.LINK flow rate control. Flow rate control means that audio data transferred via i.LINK is first stored in RAM of this unit after which the high-precision clock in the unit is used to retrieve the data from RAM to avoid the transfer jitter normally associated with i.LINK transfer. This unit transfers commands to the playback device to change the data transfer rate and control the playback device when data accumulated in RAM exceeds or goes below a certain amount due to differences in clock frequencies in the playback device and this unit. Flow rate control functions in transfers between this unit and another unit.

## How to connect multiple i.LINK-capable devices

### Daisy chain connection

You can daisy chain up to 17 devices including this unit.

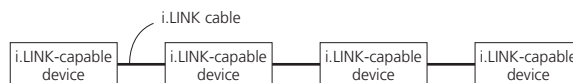

### Connection in tree structure

If you are using a device having three or more i.LINK connectors, you may want to branch out the connections. This way of connection allows you to connect up to 17 devices including this unit.

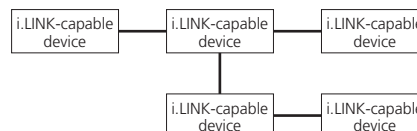

Your system does not work if data is fed back to the output device. Be careful not to create a loop.

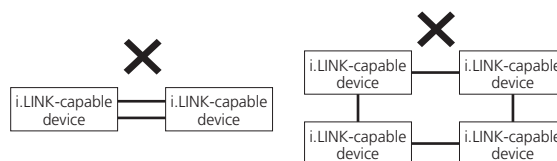

The i.LINK interface of this unit is designed in accordance with the following specifications:

- 1) IEEE Std 1394a-2000, Standard for a High Performance Serial Bus
- 2) Audio and Music Data Transmission Protocol 2.0

This unit is compliant with IEC 60958 bitstream, DVD-Audio, Super Audio CD in the AM824 sequence adaptation layers of this protocol.

In case you experience any problem with this unit, please take the time to look through this chart and see if you can solve the problem yourself before you call your dealer.

## General

### No power

- ➔ Check the connection to the AC power supply. Check and make sure the AC source is not a switched outlet and that, if it is, the switch is turned on. Make sure there is power to the AC outlet by plugging another item such as a lamp or fan.
- ➔ Press the POWER button of the main unit to turn it on.

### Remote control doesn't work.

- ➔ Press the POWER button of the main unit to turn it on.
- ➔ If the batteries are dead, change the batteries.
- ➔ Use remote control unit within the range (7m/23ft) and point at the front panel.
- ➔ Clear obstacles between the remote control unit and the main unit.
- ➔ If a strong light is near the unit, turn it off.

### Other units with remote controls operate incorrectly.

- ➔ Note that other units with remote controls may operate incorrectly because of infrared light "overspill" when you operate the remote control unit.

### There is no sound or only a very low-level sound is heard.

- ➔ Adjust the volume by turning the VOLUME knob.
- ➔ Select the proper source using the INPUT knob.
- ➔ Check that the speakers and components are connected securely.
- ➔ Check the operation of the connected component.

### No sound from a Super Audio CD.

- ➔ Digital audio from a Super Audio CD cannot go through the OPTICAL or COAXIAL terminals. Use analog audio terminals (LINE IN).

### No digital audio output.

- ➔ The AI-10 isn't equipped with Dolby Digital/DTS/MPEG decoders. The digital output setting of the connected player must be PCM. Or use analog audio terminals (LINE IN).

### Unstable sound.

- ➔ Speaker polarity (⊕/⊖) is reversed. Check all speakers for correct polarity.

## Word Sync

### The display shows "WRD ERROR!"

- ➔ The connected unit may not be in word sync mode while the AI-10 is in word sync mode. Check the word sync terminal for correct connection and the settings on the connected unit.
- ➔ The received digital signal doesn't match the sync signal. Check the frequency of the word sync signal (see page 16).
- ➔ When you don't use the WORD SYNC terminal, turn the word sync mode off (see page 13).

### Buzzing noise produced at regular intervals.

- ➔ The connected unit may not be in word sync mode while the AI-10 is in word sync mode. Check the word sync terminal for correct connection and the settings on the connected unit.  
Normally, if this problem occurs, the display reads "WRD ERROR!", but this message does not appear when deviation in sync is too small and out of the word error detection threshold of the AI-10.

## i.LINK (AUDIO) terminal

The i.LINK (AUDIO) terminals will become available after a future hardware upgrade (charged).

### No i.LINK output.

- ➔ Check the channel setting. One AI-10 unit must be set to L/R channel when multiple AI-10 units are connected.

### The i.LINK indicator blinks.

- ➔ Turn on the digital device connected to the i.LINK(AUDIO) terminal. When you don't use the i.LINK terminal, turn the i\_RC setting off.

**If normal operation cannot be obtained, unplug the power cord from the outlet and plug it again. This resets the internal micro-computer which can be disturbed during electrical storms, power interruptions, et cetera.**

## Short Circuit and Output Protection

"OVER LEVEL" blinks on the display when the short circuit protection (or the output protection) is activated. In this case, turn the unit off and check the speaker cables. The metal portions of the two separate wires should not touch. If there is no shorted wire, turn down the volume using the VOLUME knob.

## Thermal Overload Protection

"HIGH TEMP" blinks on the display when the overload protection is activated. In this case, turn the unit off and leave it for a few hours to cool it down. Also check the location of your unit. Place the unit in a cool place, and always leave sufficient space around the unit for ventilation.

# Specifications

## General

Power supply	
Europe model . . . . .	AC 230 V, 50 Hz
U.S.A./Canada model . . . . .	AC 120 V, 60 Hz
Korea model . . . . .	AC 220 V, 60 Hz
Power consumption . . . . .	135 W
Weight . . . . .	14.5 kg (31 15/16 lb)
External dimensions (W x H x D) . . . . .	442 x 149 x 383 mm (17 3/8" x 5 7/8" x 15 1/16")
Operating temperature . . . . .	+10°C - +30°C
Operating humidity . . . . .	5% to 85% (no condensation)
Storage temperature . . . . .	-20°C - +55°C

## Digital Input Terminals

Input format . . . . .	linear PCM (44.1kHz-192kHz, 16-24bit) DSD (after a future hardware upgrade (charged))
Coaxial	
Jack . . . . .	RCA x1
Input level . . . . .	more than 0.2Vp-p/75Ω
Optical	
Jack . . . . .	OPTICAL x1
Input level . . . . .	-24.0 to -14.5dBm peak

The i.LINK (AUDIO) terminals (4 pin x 1, 6 pin x 1) will become available after a future hardware upgrade (charged).

## Amplifier Section

Output Power . . . . .	110 W + 110 W (1 kHz, 8 ohms) 150 W + 150 W (1 kHz, 4 ohms)
Maximum useful output power . . . . .	150 W + 150 W (1 kHz, 8 ohms, JEITA)
Minimum impedance . . . . .	4 ohms
Total Harmonic Distortion . . . . .	0.08 % (at 110 W, 1 kHz, 8 ohms)
Frequency Response (COAXIAL, OPTICAL) . . . . .	5 Hz to 95 kHz, -3 dB (at 1 W, 8 ohms)
Signal-to-Noise Ratio (COAXIAL, OPTICAL). . . . .	more than 110 dB (JEITA)
Input Sensitivity (maximum output at maximum volume) . . . . .	LINE: 150 mVrms LINE 4 PHONO (MM): 3.2 mVrms
Input impedance . . . . .	LINE 1: 66 kΩ, LINE 2-4: 100 kΩ, LINE 4 PHONO (MM): 39 kΩ
RIAA deviation . . . . .	PHONO (MM): ±0.5 dB (20 Hz-15 kHz)

## Word Clock

Jack . . . . .	BNC
Output level . . . . .	TTL level/75Ω
Word Clock Output Frequency . . . . .	44.1, 88.2, 176.4, 48, 96, 192, 100 (kHz)

## Accessories

Power cord x 1
Remote control unit (RC-1056) x 1
Batteries (AA, R6, SUM-3) x 2
Felt sheet x 3
Owner's manual x 1
Warranty card x 1

- Design and specifications are subject to change without notice.
- Weight and dimensions are approximate.
- Illustrations may differ slightly from production models.

**Nous vous remercions pour l'achat d'un appareil Esoteric. Lire ce manuel avec attention pour obtenir les meilleures performances possibles de cet appareil.**

Sommaire . . . . .	21
Avant utilisation . . . . .	21
Branchement des enceintes. . . . .	22
Connexions. . . . .	24
Télécommande . . . . .	27
Restauration des réglages d'usine . . . . .	27
Identification des parties . . . . .	28
Fonctionnement de base. . . . .	30
Coupage du son . . . . .	31
Atténuation de l'afficheur. . . . .	31
Synchronisation Word. . . . .	31
Réglage de gain pour l'entrée audio analogique . . . . .	32
Réglage de nom et de saut d'entrée de la commande INPUT. . . . .	33
Réglages de synchro Word, volume et i.LINK*. . . . .	34
i.LINK (IEEE 1394)* . . . . .	36
Guide de dépannage . . . . .	37
Caractéristiques . . . . .	38

\*: Les fonctions relatives aux prises i.LINK (AUDIO) n'ont pas d'effet pour le moment. Elles deviendront opérationnelles après installation d'une future option (payante).

« Super Audio CD » est une marque déposée.  
« DSD » est une marque déposée.

Le logo i.LINK est une marque commerciale de Sony Corporation, déposée aux U.S.A. et dans d'autres pays.

### Contenu de l'emballage

Veuillez vérifier que les accessoires suivants se trouvent dans l'emballage après l'avoir ouvert.

- Télécommande x 1
- Piles (AA, R6, SUM-3) x 2
- Feutrines x 3
- Cordon d'alimentation x 1
- Mode d'emploi x 1
- Carte de garantie x 1

### Lisez ceci avant utilisation

- Faites attention de ne pas vous blesser lors du déplacement de l'appareil, en raison de son poids. Faites-vous aider si nécessaire.
- Pour protéger le mobilier facilement rayable, vous pouvez coller aux pieds de l'appareil la feutrine fournie avec celui-ci.
- Comme l'appareil peut devenir chaud durant son fonctionnement, laissez toujours suffisamment d'espace autour de lui pour la ventilation.  
Les orifices de ventilation ne doivent pas être obstrués. Vérifiez qu'il y ait au moins 20 cm d'espace au-dessus et 5 cm d'espace de chaque côté de l'appareil. Ne placez RIEN sur l'appareil.
- La tension électrique fournie à l'appareil doit correspondre à celle imprimée sur sa face arrière. En cas de doute à ce sujet, consultez un électricien.
- Choisissez soigneusement l'emplacement d'installation de votre appareil. Evitez de le placer en exposition directe au soleil ou près d'une source de chaleur. Evitez aussi les lieux soumis à des vibrations et à des conditions excessives en termes de poussière, chaleur, froid ou humidité.
- Ne placez pas l'appareil sur l'amplificateur/récepteur.
- N'ouvrez pas l'appareil car cela pourrait endommager les circuits ou causer un choc électrique. Si un objet étranger a pénétré dans l'appareil, contactez votre revendeur ou un centre d'assistance technique.
- Quand vous débranchez le cordon d'alimentation de la prise secteur, tirez toujours directement sur la fiche, jamais sur le cordon.
- N'essayez pas de nettoyer l'appareil avec des solvants chimiques car cela pourrait endommager la finition. Utilisez un chiffon sec et propre.
- Conservez ce manuel en lieu sûr pour vous y référer ultérieurement.

# ESOTERIC

---

<b>TEAC ESOTERIC COMPANY</b>	3-7-3, Nakacho, Musashino-shi, Tokyo 180-8550, Japan Phone: (0422) 52-5132 e-mail: eso-os@tec.teac.co.jp
TEAC AMERICA, INC.	7733 Telegraph Road, Montebello, California 90640 Phone: (323) 726-0303
TEAC CANADA LTD.	5939 Wallace Street, Mississauga, Ontario L4Z 1Z8, Canada Phone: (905) 890-8008
TEAC MEXICO, S.A. De C.V	Campesinos N°184, Colonia Granjas Esmeralda, Delegacion Iztapalapa, CP 09810, México DF Phone: (525) 581-5500
TEAC UK LIMITED	Unit 19 & 20, The Courtyards, Hatters Lane, Watford, Hertfordshire, WD18 8TE, U.K. Phone: (0845) 130-2511
TEAC EUROPE GmbH	Bahnstrasse 12, 65205 Wiesbaden-Erbenheim, Germany Phone: 0611-71580

---

This appliance has a serial number located on the rear panel. Please record the model number and serial number and retain them for your records.

Model number \_\_\_\_\_ Serial number \_\_\_\_\_

0307·MA-1193A